

SCS CAM-X Manual

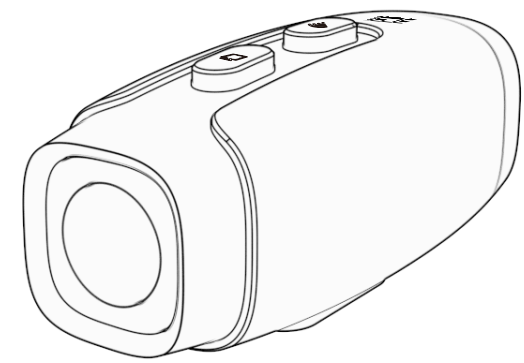

Package Contents

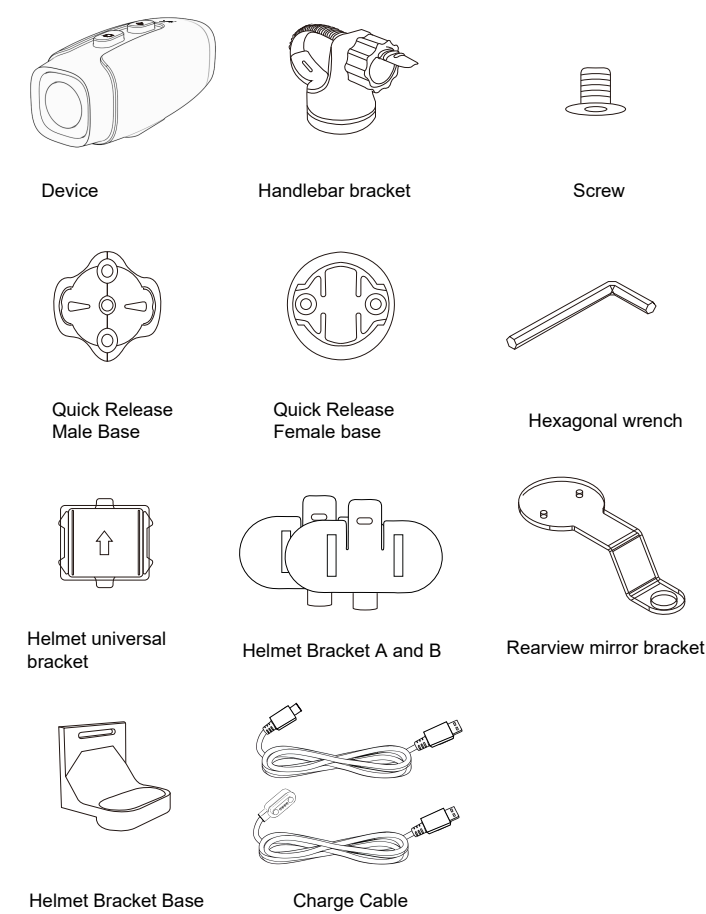

Description

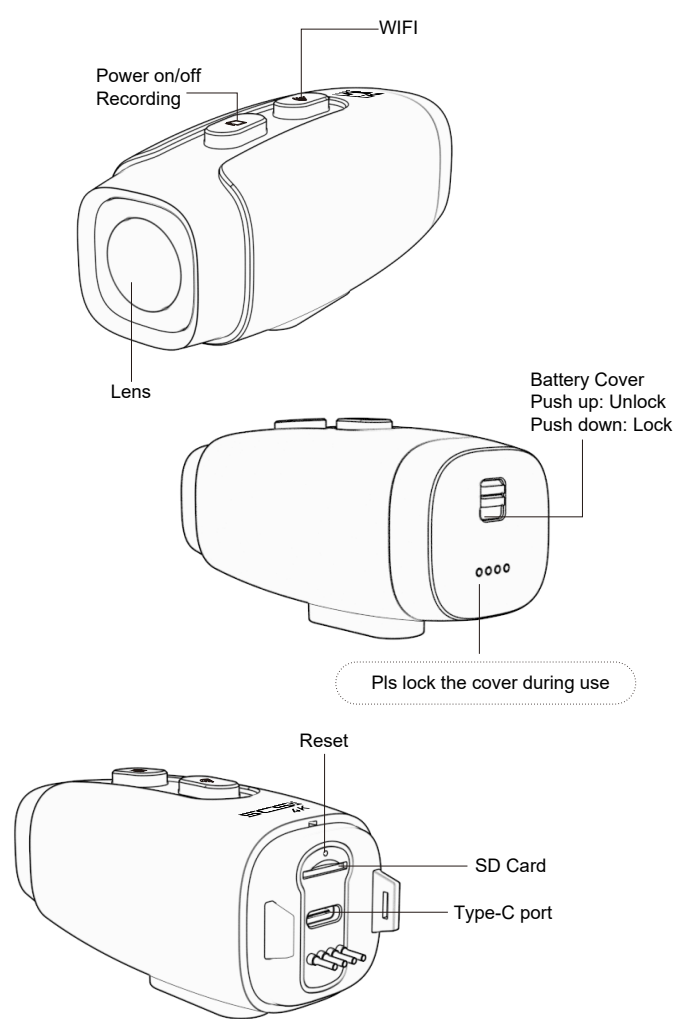

Remark: Insert SD card before work

Basic Function

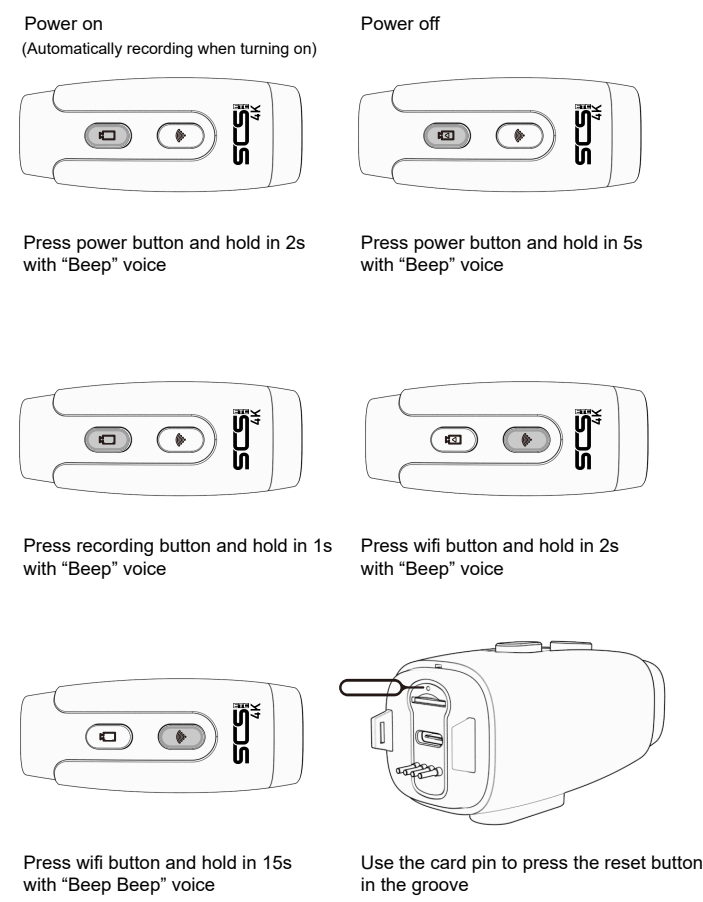

Remark: After booting up, if the prompt tone sounds a long "beep" alarm, it means that the SD card is not installed or the SD card is not installed properly.
WIFI reset: WIFI device name and password will be restored to the factory default state.
Reset button: When the device freezes or freezes, it can be restored to normal operation.

Install on the motorcycle mirror

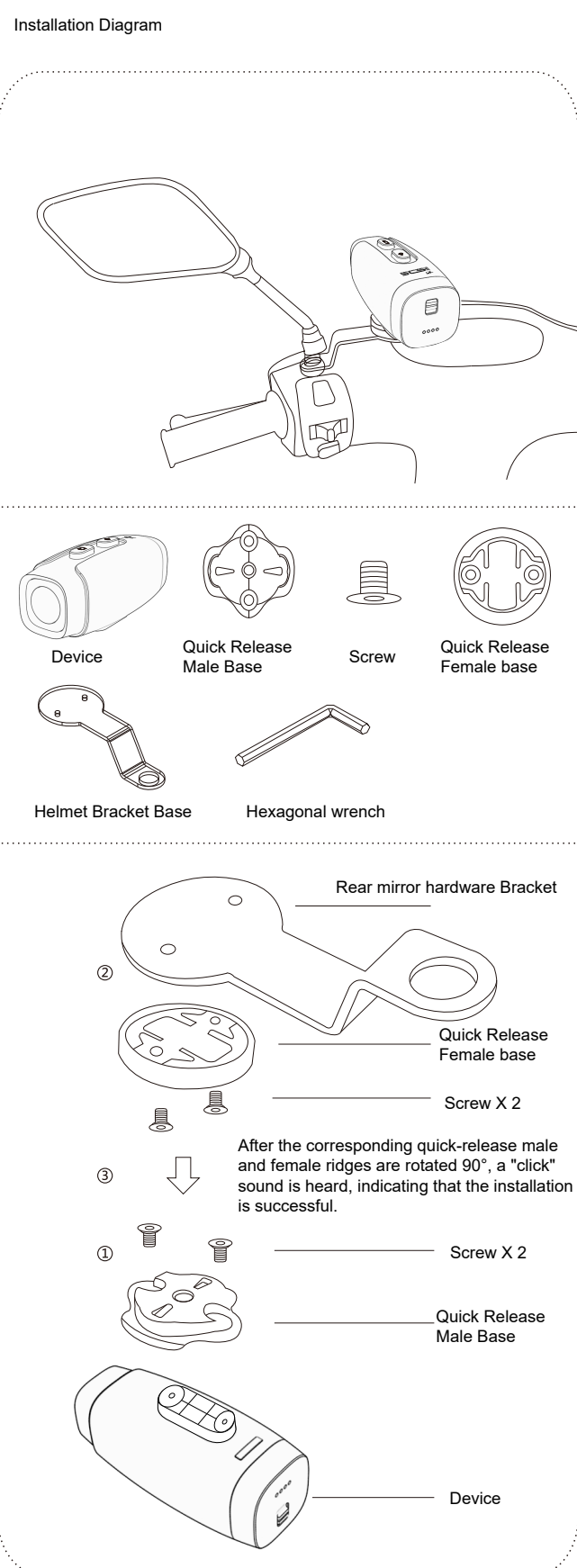

Installation Diagram

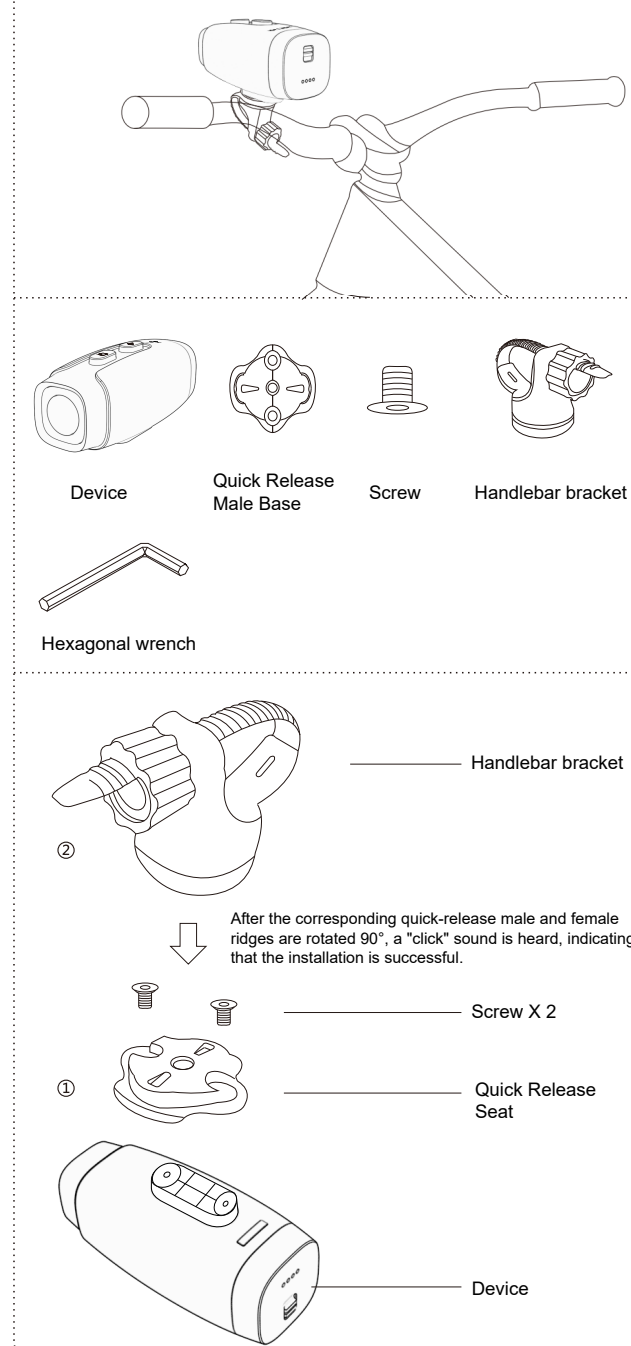

Install on helmet:

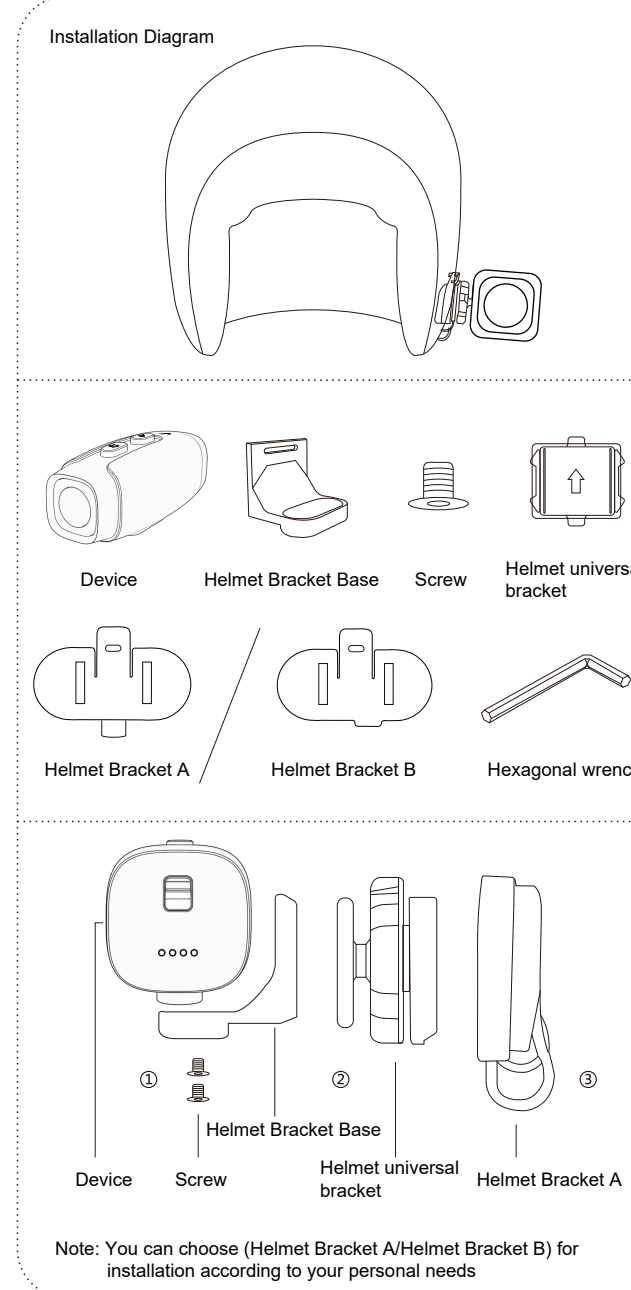

Note: You can choose (Helmet Bracket A/Helmet Bracket B) for installation according to your personal needs

Charging Tutorial

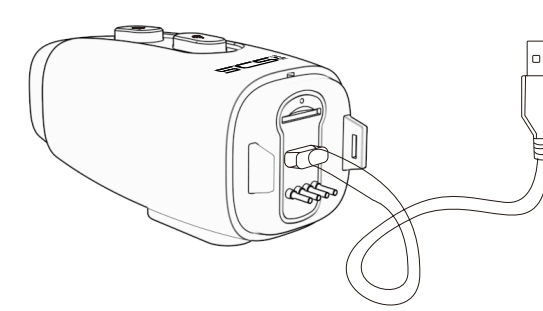

Plug the USB port into a power source and charge normally.

Note: If you want to charge and use at the same time, you need to lock the battery cover switch "pushing down" to lock it.

Download APP and connection

1 Download APP

REMARK When using CAM-X at first time, please be sure to connect to QS CAMERA to update the recording time in real time.

Please scan the QR code below to download and install the [QS CAMERA] APP, and allow location information services and camera access.

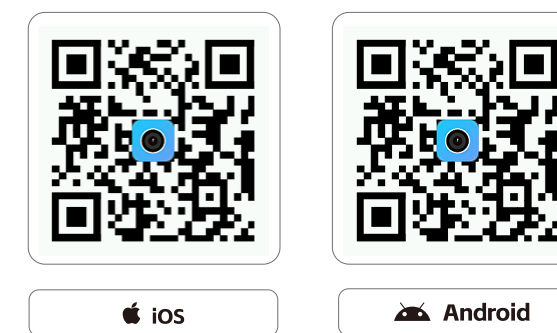

2 Connect your phone to the CAM-X WIFI

When CAM-X is turned on, you need to manually turn on WIFI to connect

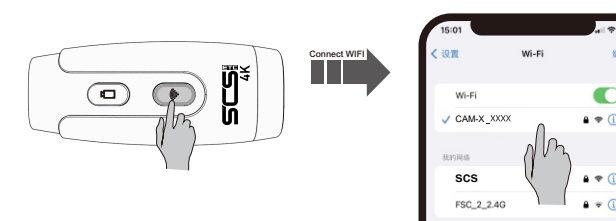

Turn on CAM-X device, then press and hold the WWIFI button for 2 seconds to turn on WIFI.

Check the phone's WIFI settings, search for connection "CAM-X_XXXX" *WIFI password: 1234567890

3 Real-time video recording

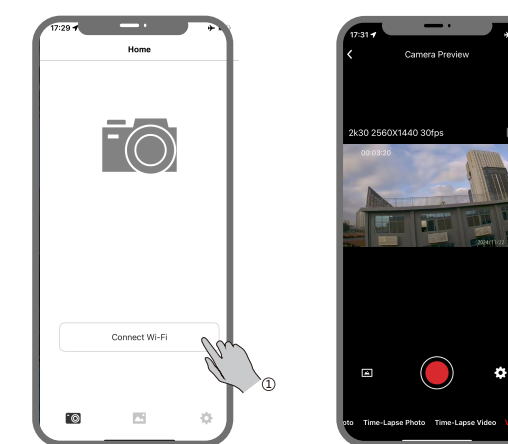

1 Click "Connect Wi-Fi" to see the real-time video:

4 Set the parameters

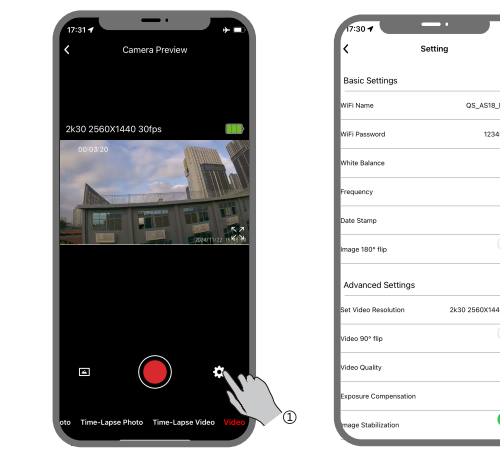

1 Click "Settings" in the upper right corner to set various parameters:

5 View Recording Video

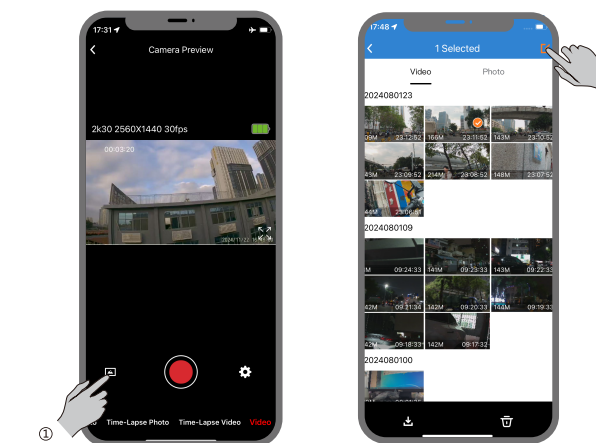

1 Click "Photo" to view the recorded videos/pictures;
2 Click "Select" to download the files;

6 View Download Video

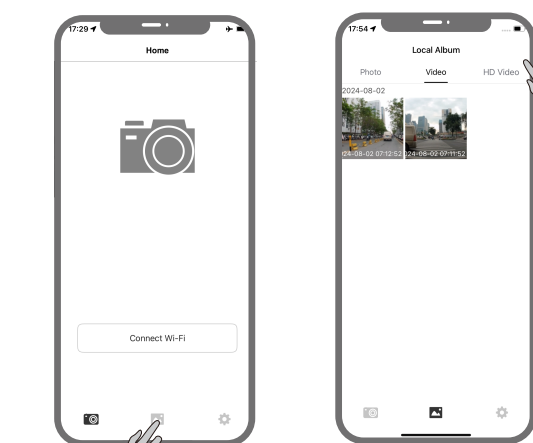

1 Click "Album" to view the downloaded files;
2 Click "Select" to download the files to the mobile phone album

Lighting status

Function status	Indicator status	Prompt sound
Power on	Orange light flashing	Long "beep" sound
Power off	Light off	Loud "beep" "beep" "beep" "beep" sound
Start recording	Orange light flashing	Loud "beep" sound
Pause recording	Orange light on	Loud "beep" sound
Turn on WIFI	WIFI button orange light flashing	Loud "beep" sound
Turn off WIFI	WIFI button Light off	Two "beep" sounds
SD card abnormality	White light on	When there is no card, it will be a long "beep" sound
WIFI reset	Orange light on + White light flashing once	Loud "beep" sound
When the battery is low	White light flashing quickly	Long "beep" sound every 3 minutes
Charging	White light on	/
Fully charged	Blue light on	/

WARNING

Upgrade software
Copy the new firmware to the SD card. When the host is turned off, insert the SD card into the host and then start the upgrade. The device cannot be powered off during the upgrade! The upgrade takes about 1 minute, please wait patiently. After the upgrade is completed, the device will automatically restart and start up. (New firmware needs to be collected at the place of purchase)

Upgrading: Orange light flashes quickly
Upgrade completed: Long "beep" sound

Memory size Shooting time

Capacity	(720P/30fps)	(720P/60fps)	(1080P/30fps)
256GB	About 142h	About 78h	About 61h
128GB	About 71h	About 39h	About 31h
64GB	About 36h	About 19h	About 15h
32GB	About 18h	About 10h	About 8h

Specifications

Product model	CAM-X
Recording pixels	4K/30fps 1080P/30fps 720P/60fps
Wide - angle lens	115°/F1.8
Waterproof level	IPX6
Recording time	About 9h
WIFI signal	2.4GHz
WIFI device name	CAM-X_XXXX
Default password	1234567890
Recording format	MP4, 16: 9
Maximum memory	256GB
Lithium battery	2600mAh/3.8V/2C
Charging time	About 100 minutes
Charging voltage	DC 5V
Charging current	≤2.1A
Working voltage	≤4.2V
Working current	≤400mA
Temperature environment	-20°C to 60°C (-4°F to 140°F)
Applicable models	Motorcycle/Electric Vehicle/Bicycle

For precautions related to this product, please refer to the following instructions:

- Storage/usage temperature of the recorder: -20°C to 60°C (-4°F to 140°F)
- Do not use irritating chemical solvents for cleaning. It is recommended to wipe with a slightly damp paper towel or soft cloth
- Please pay attention to environmental hygiene, do not discard it at will, and do not throw the product into the fire to avoid explosion
- Do not disassemble the shell or repair it yourself. If this product fails, please contact the merchant's official customer service for relevant consultation.
- Please strictly abide by local laws and regulations to avoid infringing on the rights of third parties, including but not limited to publicity rights, intellectual property rights, data rights or other privacy rights. You may not use this product for weapons of mass destruction, biological and chemical weapons, nuclear explosions, or any unsafe use of nuclear energy or infringement of human rights.

After-sales replacement/repair instructions:

From the date of purchase, users can get a one-year replacement and lifetime repair for any quality problems of the product (repair costs are at their own expense)

-The following situations are not covered by the replacement scope

-Improper use environment or conditions, such as: ambient temperature, lightning strike, etc., which lead to product failures due to improper installation, incorrect use, unauthorized disassembly, dropping, force majeure events or other external reasons

-Any failure or defect caused by the use of third-party products, software or components.